

XC-9242V

IP Outdoor Video Intercom Station

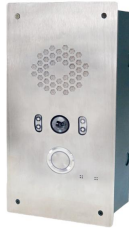

SPON IP Outdoor Video Intercom Station XC-9242V is designed for outdoor environment use ,stable and durable.This station is typically used as a communication, or emergency point and connects directly to the IP network making it easy to deploy anywhere and at any distance.

MAIN FUNCTIONS

- 1.Stable, durable all-metal shell and violence-resistible with a waterproof ratio of IPX5.
- 2.With the "one-touch call" function (by pre-setting up the target on the server), available for a full-duplex intercom.
- 3.Built-in 10W speaker and microphone; available for making hands-free calls and receiving the broadcasting.
- 4.With a built-in 40W digital amplifier module; available for connecting with the external column loudspeaker or horn peaker (8 Ω).
- 5.With infrared fill light and a built-in HD wide-angle camera (1080P) which adopts the H.264 coding format to realize HD video intercom.
- 6.Compatible with standard SIP protocol and it can be registered to VOIP phone system Independently.
- 7.Comply with standard ONVIF interface protocol, available for directly connecting to the mainstream NVR and other storage devices to realize audio and video recording synchronously for traceability.
- 8.With 2 alarm inputs for connecting external emergency buttons.
- 9.With a controlled power supply output of DC12V/500mA to directly drive strobe light.
- 10.With a standard RJ45 interface supportive of crossing network segment and router, accessible to the system if the Ethernet is available.

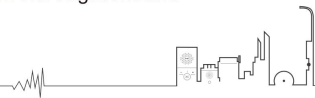

SPECIFICATION

Power Parameters

Power Supply:DC 24V/2.7A

Power Consumption:≤90W

Audio & Video Parameters

Audio Codec:WAV, PCM, ADPCM

Audio Sampling & Bit Rate:8kHz~44.1kHz, 16bit, 8kbps~320kbps

Built-in Speaker:40W ,8Ω

S/N(Broadcast-Speaker):>80dB

Built-in Mic Sensitivity:-45±3dB

Built-in Camera:1/3" CMOS

Built-in Camera Aperture and Focal Length:F2.0 ,2.3mm

Video Coding:VGA/720P/1080P

Video Transmission Bit Rate:128Kbps-10Mbps

Network Parameters

Network I/F:10BASE-T/10BASE-TX RJ45

Network Protocol:TCP/IP、UDP、ARP、ICMP、IGMP、SIP、HTTP

Configuration Method:Web Interface or DevConfig Tool

Mechanical&Environment Properties

Mounting Method:Embedded-mounted

Installation Environment:Outdoor Locations

Operating Temperature:-30℃~+55℃

Operating Humidity:≤90% RH non-condensing

Shell Material:Stainless Steel

Color:Silver

Product Dimensions:360x252x74mm

Protection Level:IPX5

Product Warranty:2 Years Limited

Accessories

1×Waterproof Connector

3×Plastic expansion sleeve(M8*40)

2×Terminal(3.81-4P)

4×Terminal(3.81-3P)

4×Hexagon socket screw(M8*18)

1×Power Adaptor(DC24V/2.7A)

3×Half Round Head Phillips Screw(M6*40)

1×Quick Installation Guide

1×Certificate and Warranty Card

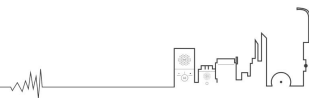

INTERFACE DESCRIPTION

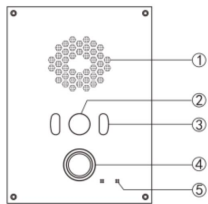

- ① Speaker
- ② Built-in Camera
- ③ Fill Light
- ④ Call Button: The call target can be defined on SPON management software XC-9000.
- ⑤ Built-in Mic

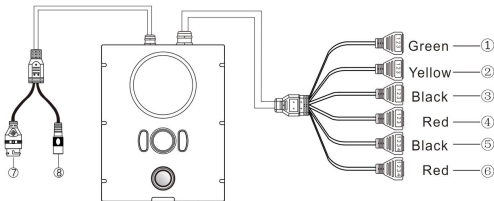

- ① Relay Output: 1-NO, 2-NC, 3-COM
- ② Relay Input: 1-GND, 2-Relay In 1, 3-Relay In 2
- ③ Communication Port: 1-GND, 2-T/R, 3-GND
- ④ Line Input & Output :1-Line In, 2-GND, 3-Line Out
- ⑤ Controlled Power Output: 1-Light 4, 2-Light 3, 3-Light 2, 4-Light 1
- ⑥ Power Amplifier Output: 1-Right Channel +, 2-Right Channel -, 3-Left Channel +, 4-Left Channel -

Note:

- 1. External power amplifier support 1*40W/ 4 ω or 2*20W/ 8 ω horn;
- 2. Loudspeaker polarity and channel output polarity connection must be corresponding;
- ⑦ Ethernet Port: To Ethernet Switch
- ⑧ Power Input: DC24V, 2.7A

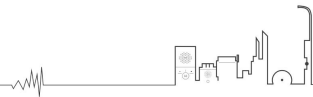

CONNECTION DIAGRAM

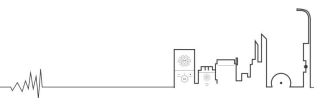
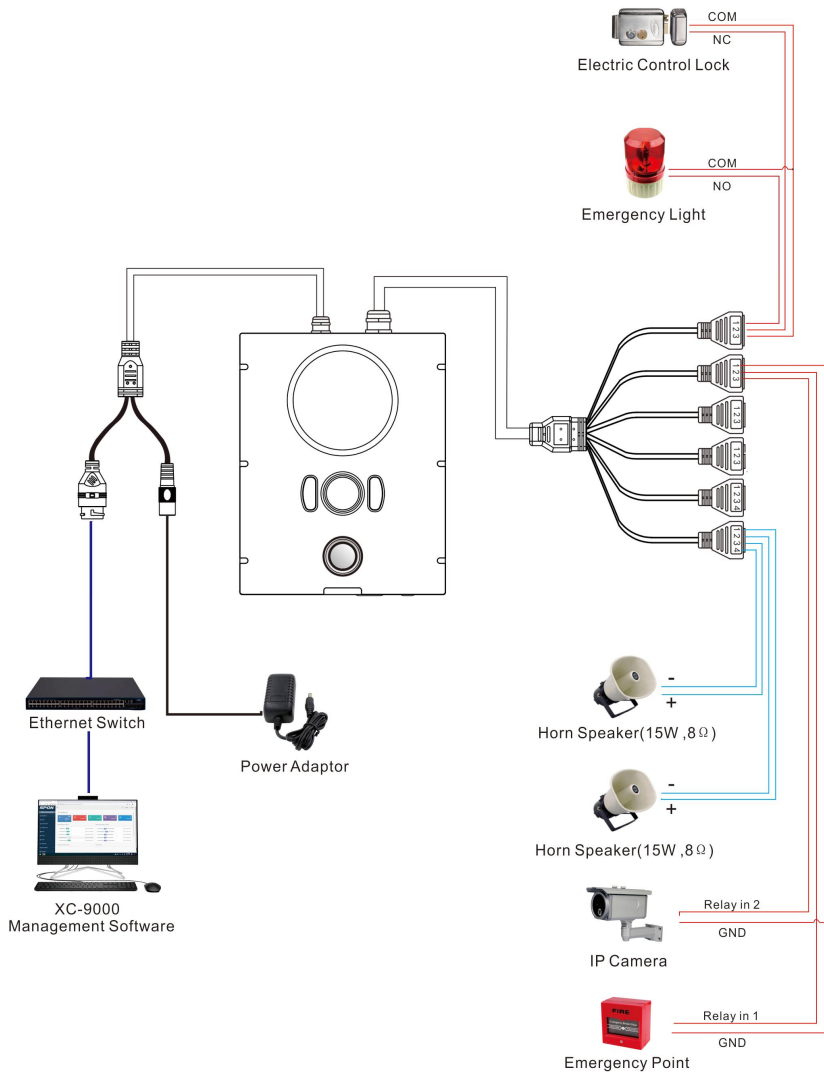

APPLICATION

Application 1

IP Outdoor Video Intercom Station XC-9242V Support initiate&receive sip calling with the third-party SIP PBX via SIP trunk .In addition, as a SIP endpoint, it can be independently registered to SiP PBX to call with SIP phone or SIP softphone.

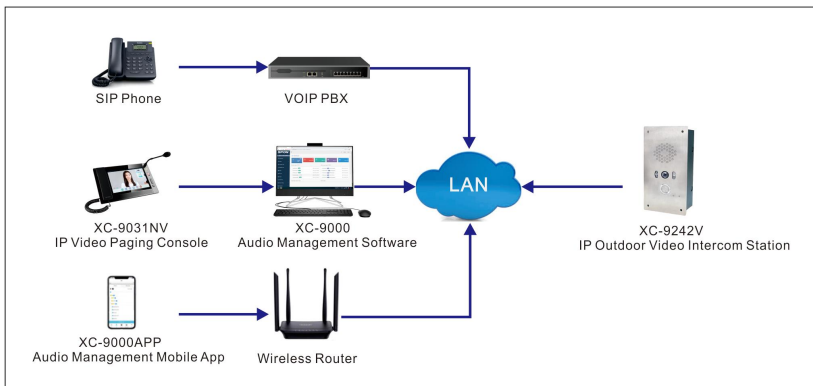

Application 2

IP Outdoor Video Intercom Station XC-9242V support initiating and receiving offline calling to designated endpoints or IP paging mic , the offline call target can be set on its webpage.

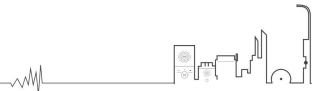
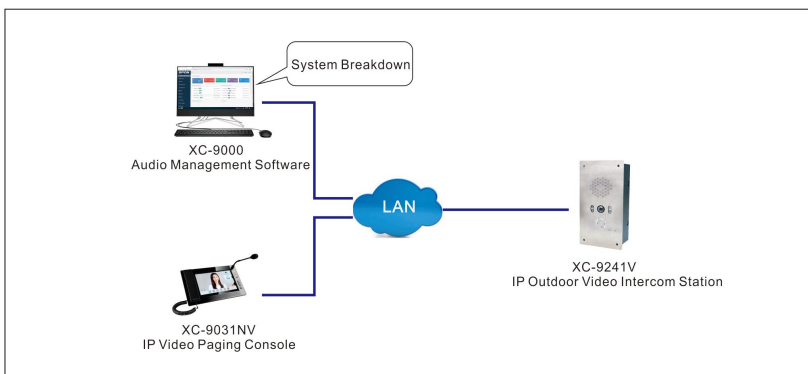

Application 3

IP Outdoor Video Intercom Station XC-9242V has a built-in amplifier which can drive external passive speaker , when broadcasting from software or IP paging mic , the output sound of XC-9241V can be defined to output from external passive speaker.

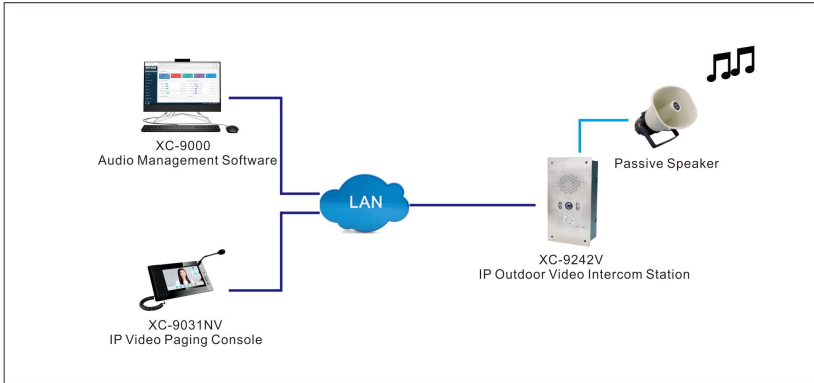

Application 4

IP Outdoor Video Intercom Station XC-9242V can binding with 3rd party IP camera on management software XC-9000. During Intercom with IP paging mic ,you can switch between XC-9241V and IP camera video display on paging microphone.

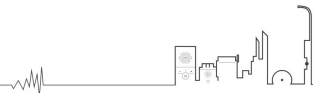
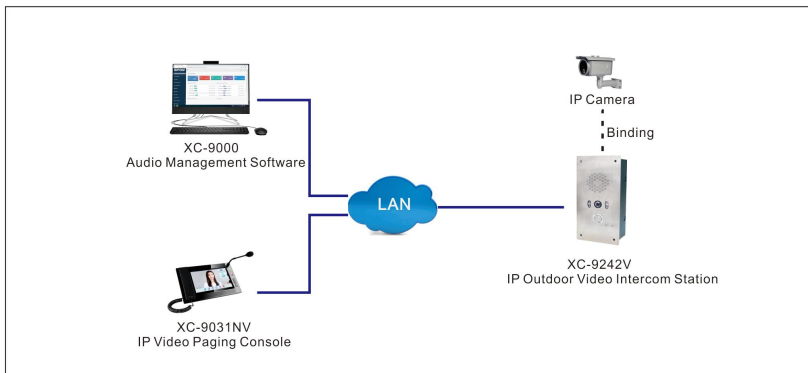

DIMENSIONAL DRAWING

